

# Stack Chair Depot

## Manhattan Assembly Instructions

Thank you for selecting Stack Chair Depot for your seating requirements. In a few minutes you will have a high quality piece of furniture that you will enjoy for many years. Please follow the instructions below to assure the proper assembly.

First, confirm that all pieces are included as described here. Unwrap and layout pieces on floor ready to assemble. Estimated time to assemble is 12 minutes.

#1 Chrome base disc



#2 Chrome plated plastic collar



#3 Short chrome column



#4 Long Chrome column



#5 Footrest ring



#6 Upholstered seat

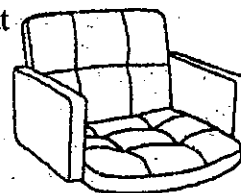

#7 Upper column with plate

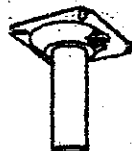

#8 Plastic bag with 4 bolts, 4 washers, 1 Allen wrench



Start assembly by placing the base disc #1 on the floor. Center the plastic collar #2 over the hole in the disc. Insert the short chrome column #3 through the plastic disc and into the base. Note: the column has a slight taper at both ends. Either end can go into the base. Next insert the long column #4 into the top of the short column with the pointed end up. Finally, place the footrest over the top of the long column and allow it to move down until it stops. There is a wider section of the long column that will lock the footrest in place at the correct height.

(over)

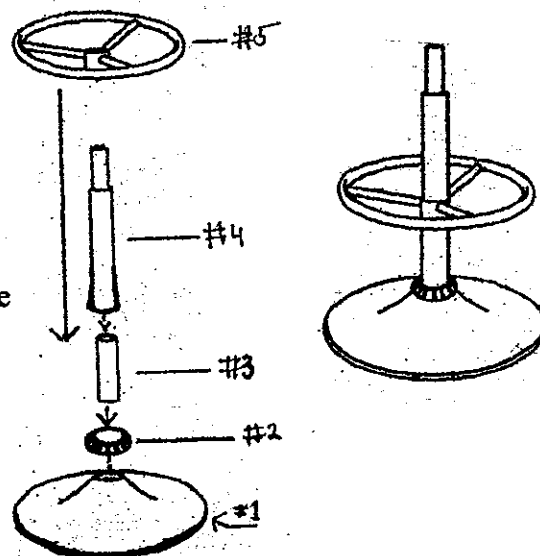

Next, open bag of bolts and washers #8. Place a washer on each bolt and set them close by, ready to use. Then place upholstered seat #6 upside down on the floor, preferably on carpet or rug. Position the top plate of the upper column #7 with plate against the underside of the seat. Line up the holes in the plate with the threaded holes in the seat bottom.

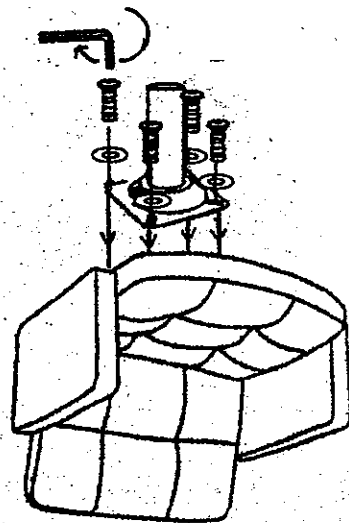

Begin attaching the column with plate to the seat bottom by turning bolts clockwise into threaded holes using only your hand. Be sure that there is no black cloth in the holes since that will interfere with the bolt threads. Turn bolts by hand until you feel a tightening. Note: There is a blue substance on the bolt threads to prevent them from working loose once completely tightened. After all four bolts are started by hand, tighten down completely using the Allen wrench until the plate is firmly seated against the bottom of the chair.

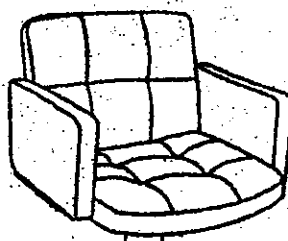

Finally, turn seat with column attached upright and place over top of pointed column on the base disc. Sit on completed chair carefully. This pressure will lock all parts into the base system.

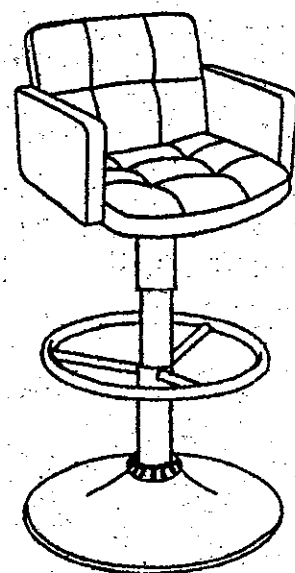
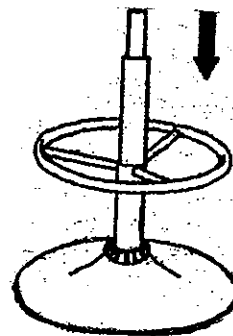

Your Manhattan barstool is now assembled and ready to enjoy. It will easily swivel around on the heavy duty chrome base. Spills and food substances should be wiped off the upholstery with a damp cloth as soon as possible.

For your comments or problems call Stack Chair Depot between 8:00 AM and 5:00 PM Eastern Time on business days. *We thank you for your business.*